

fischer[®]technik

50

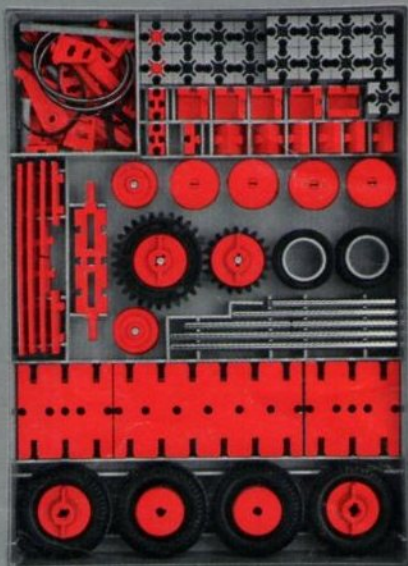

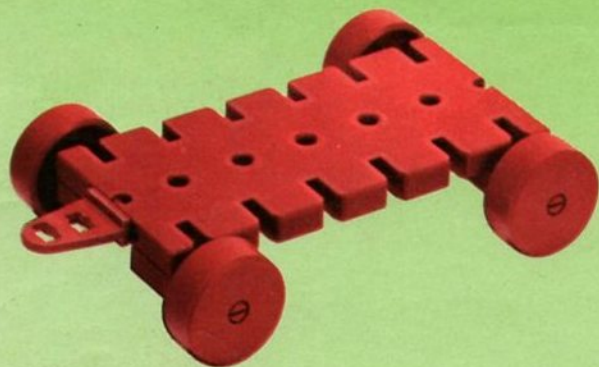

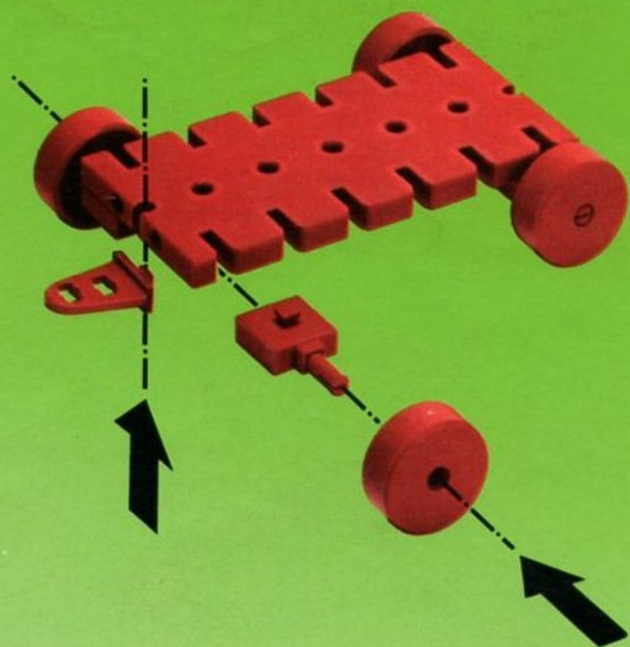
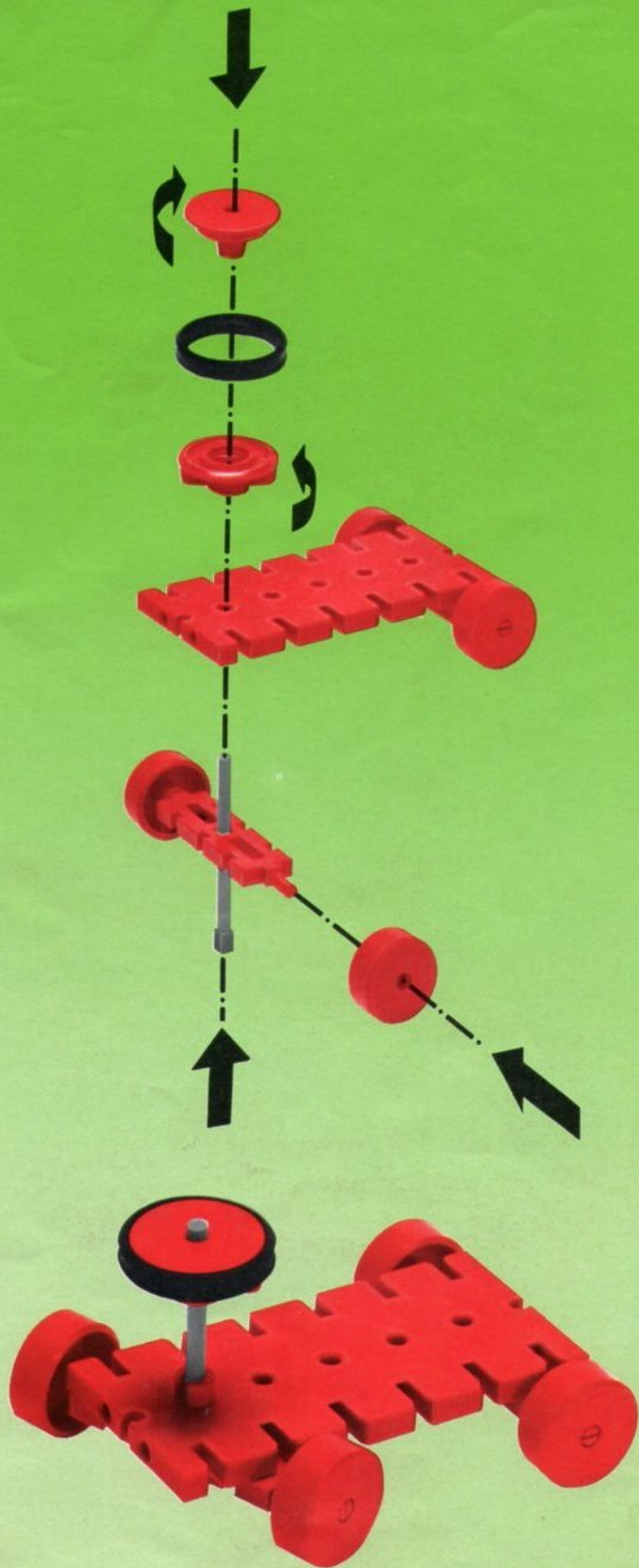

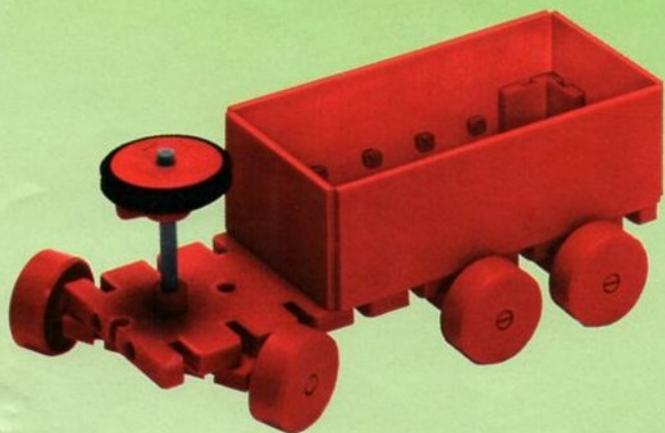
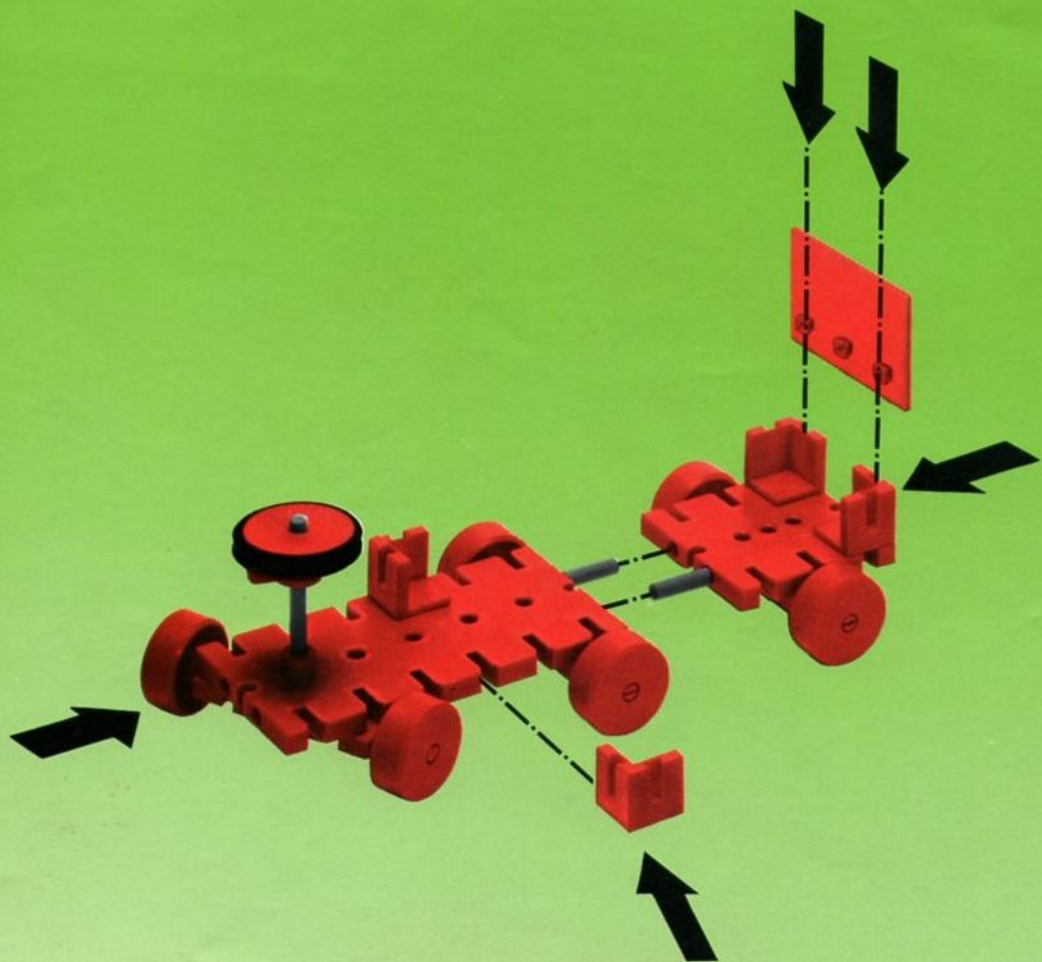

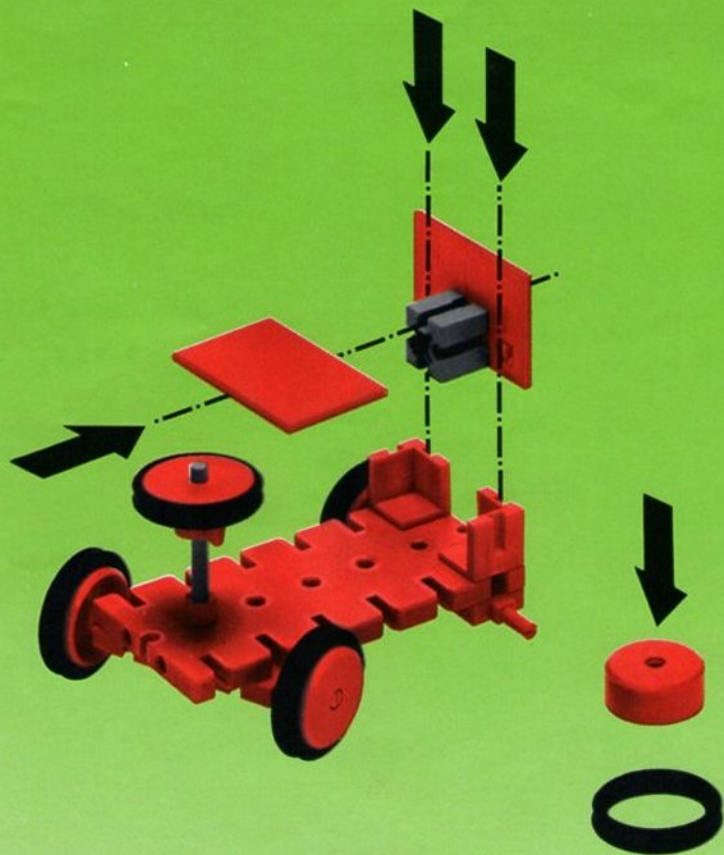

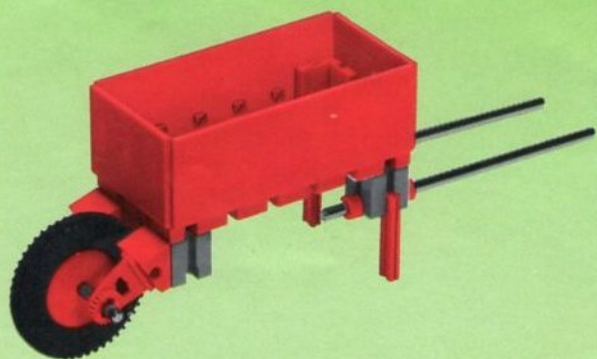
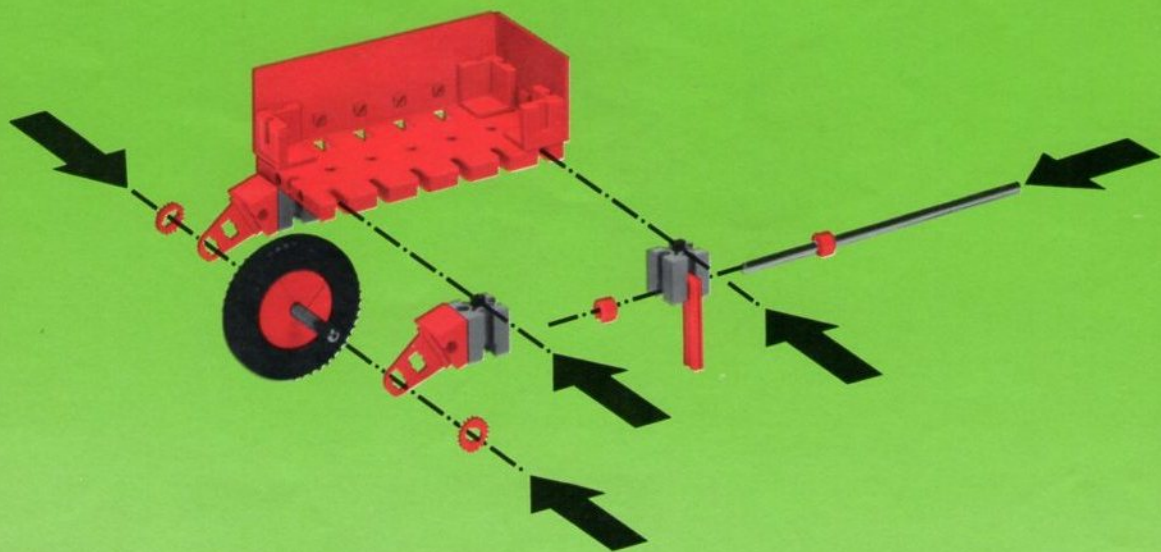

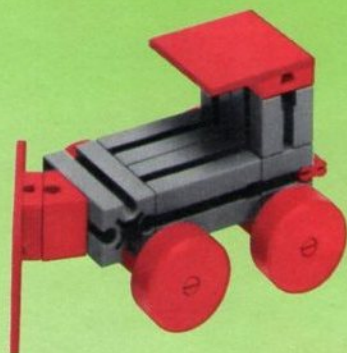
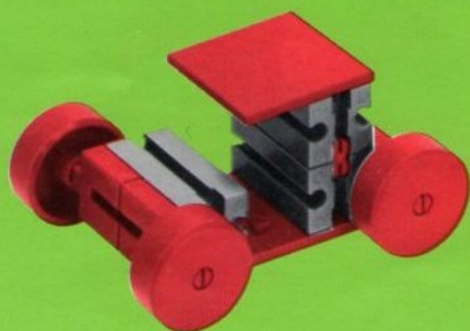

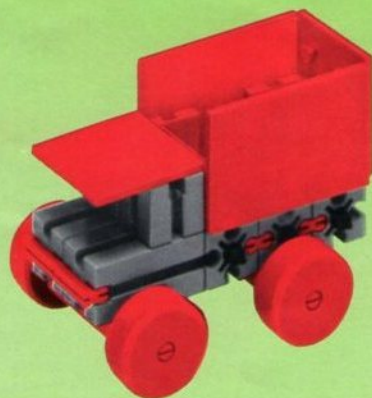
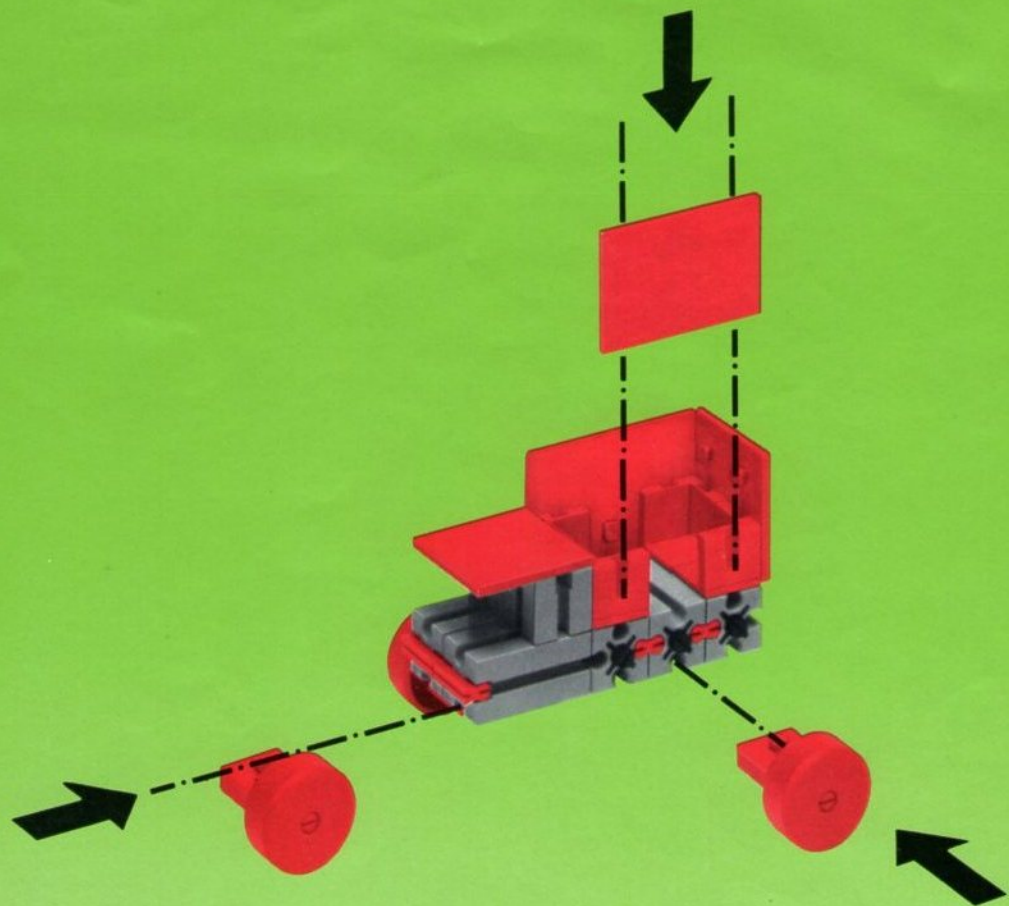

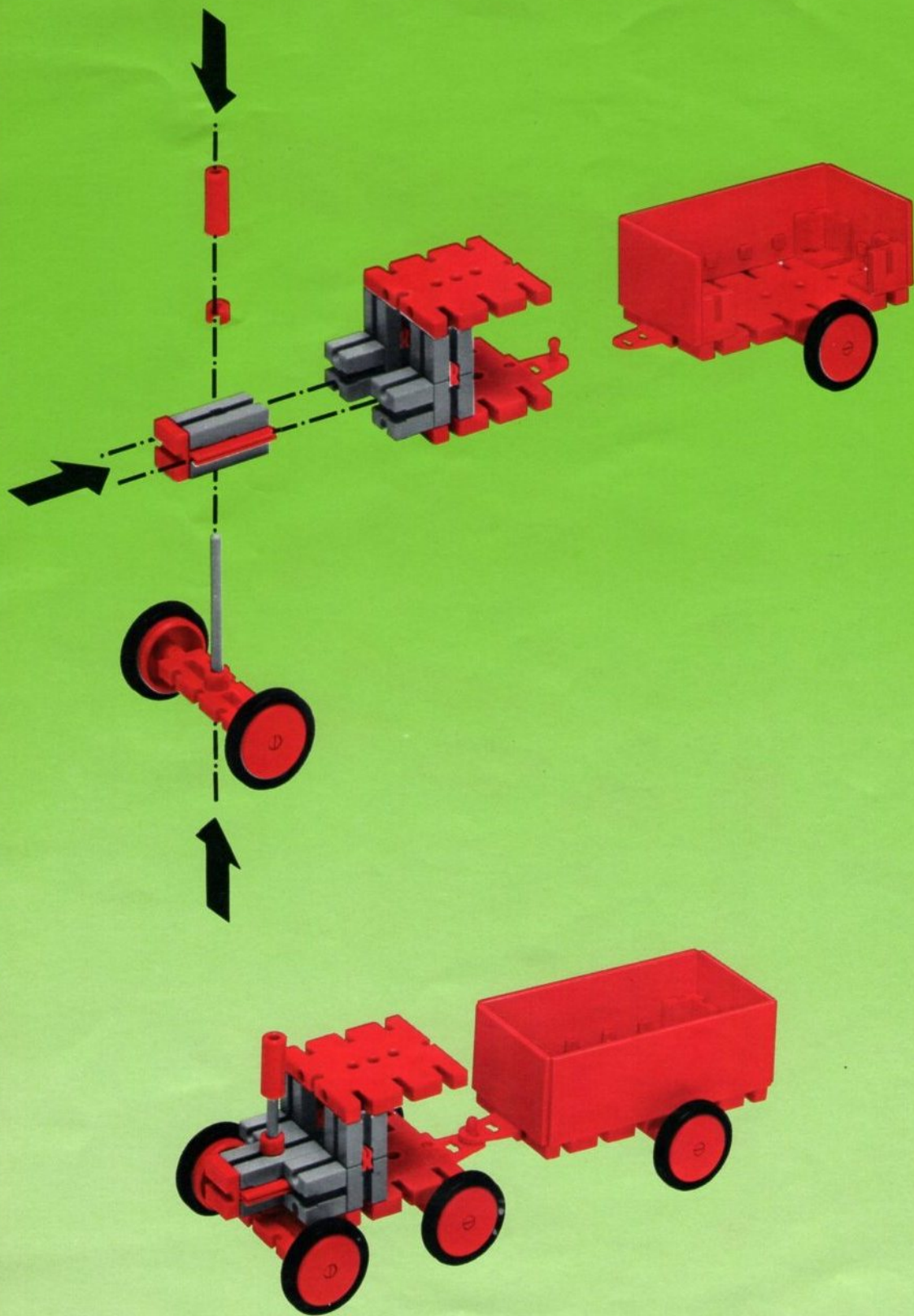

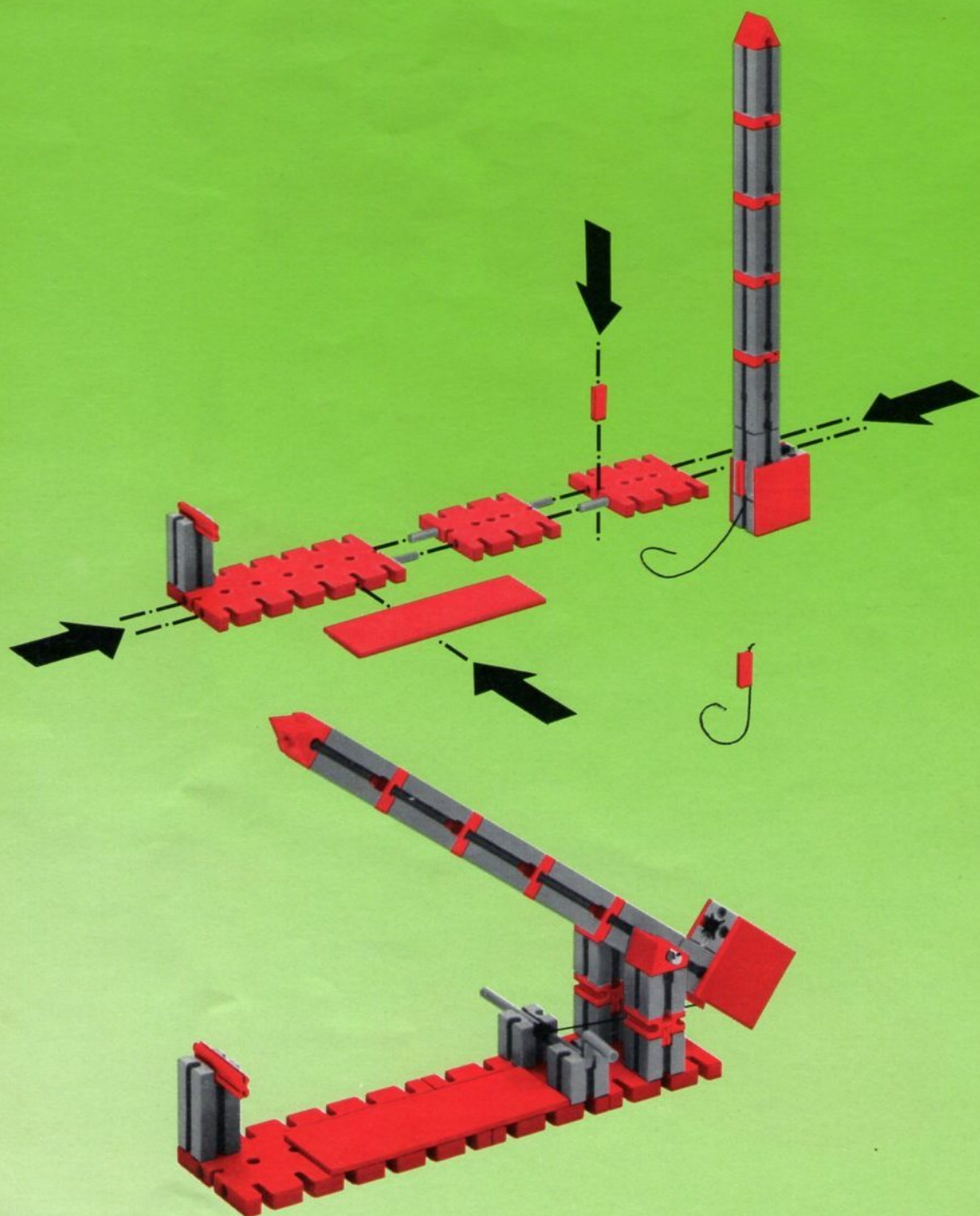

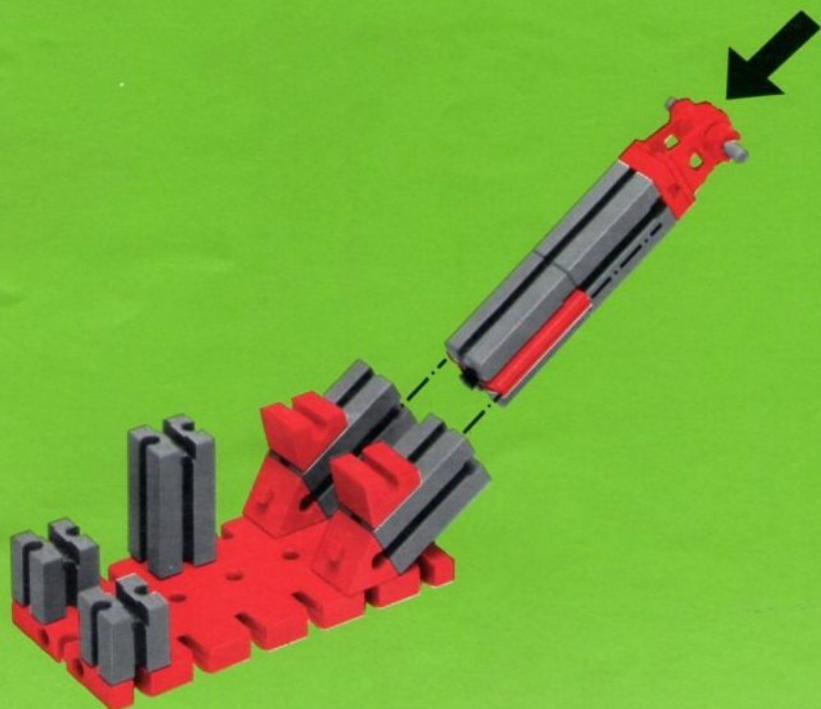

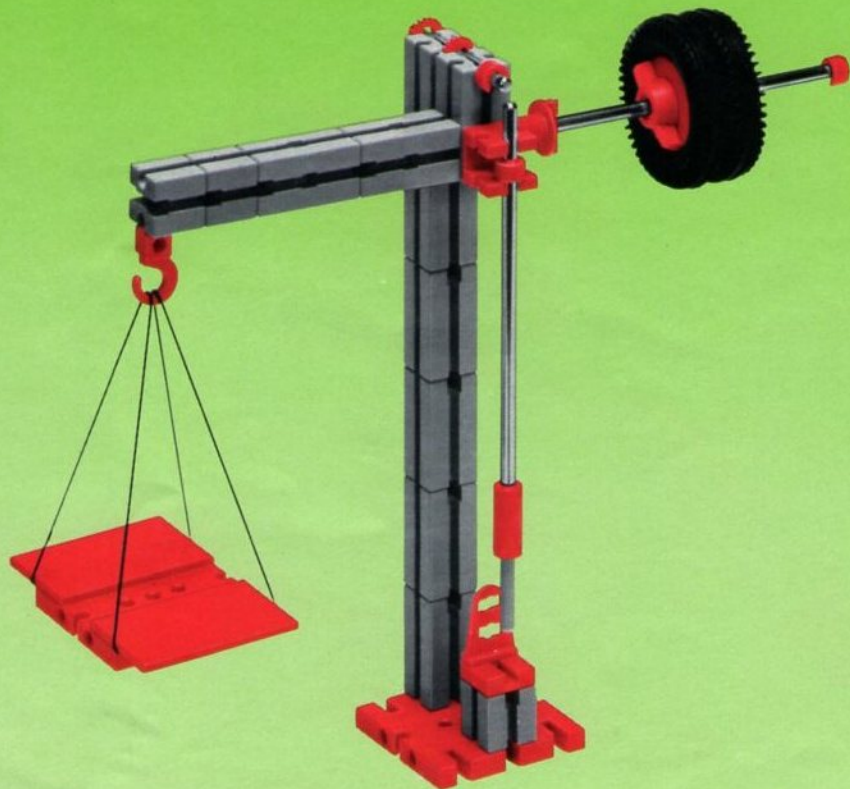
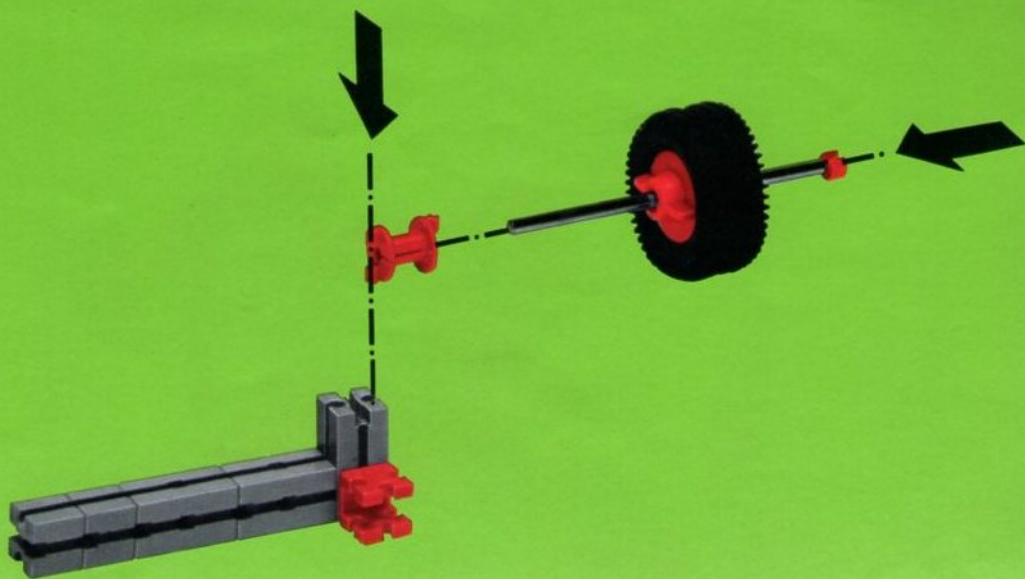

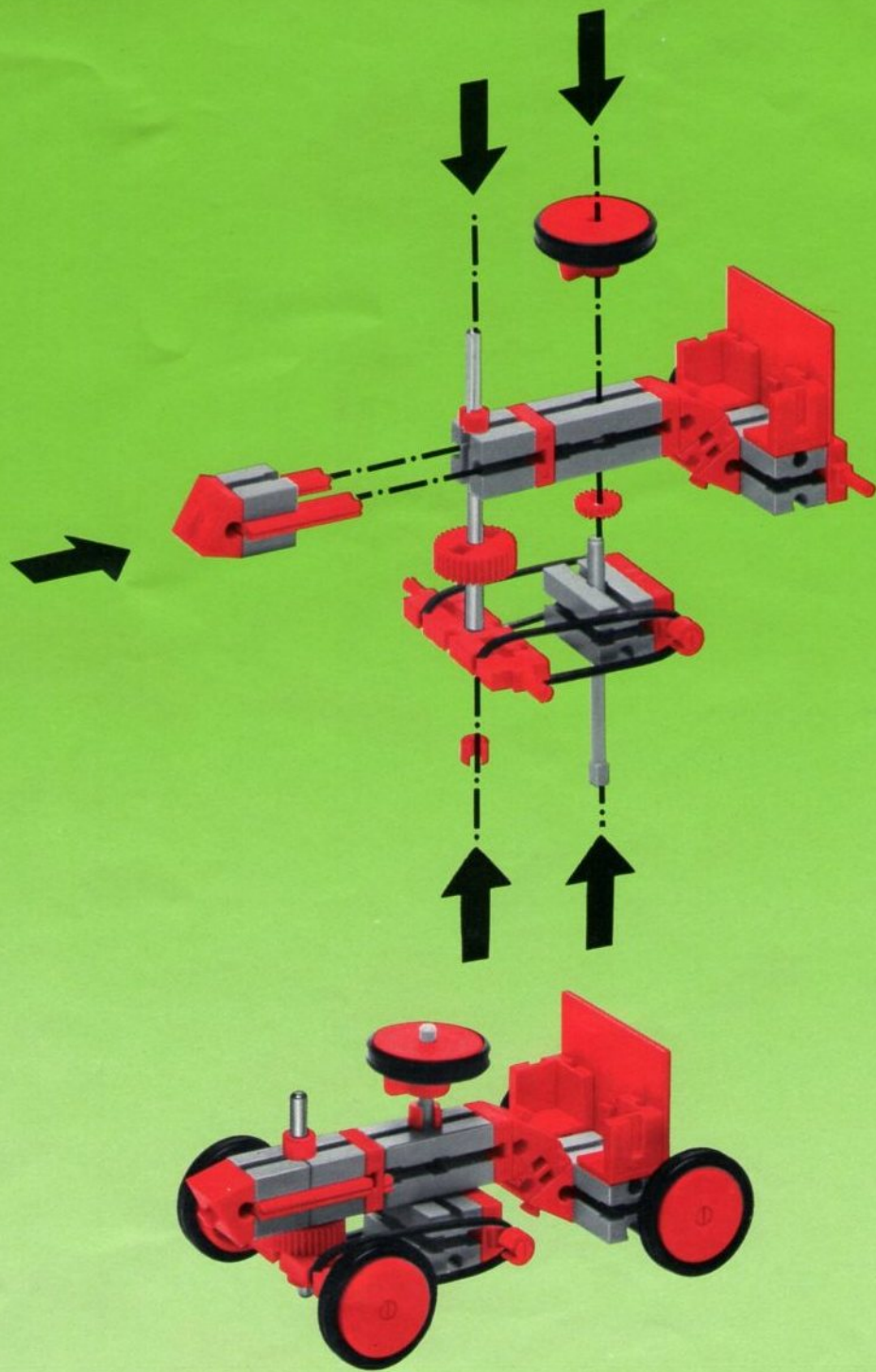

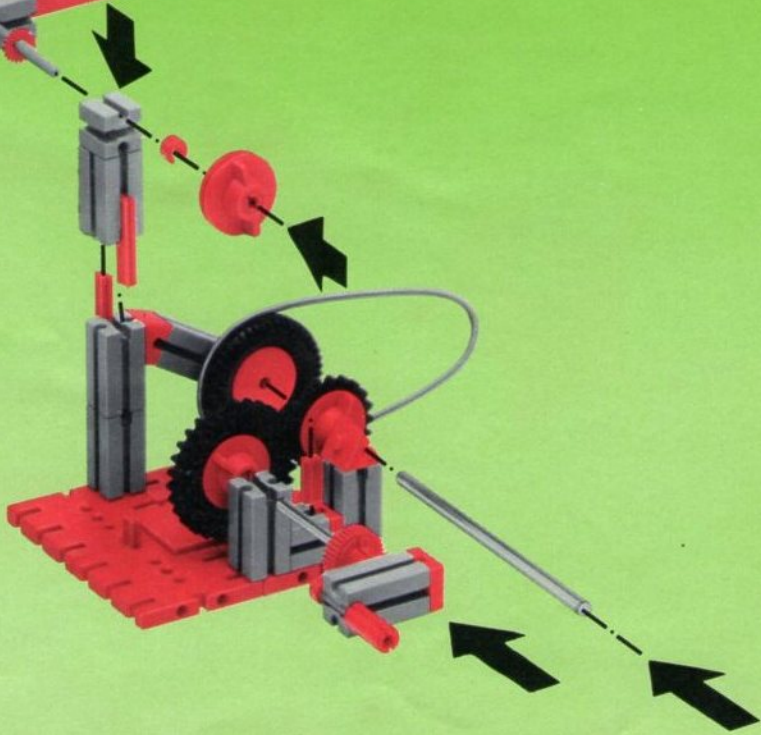
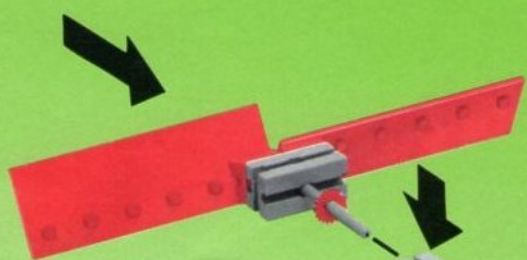
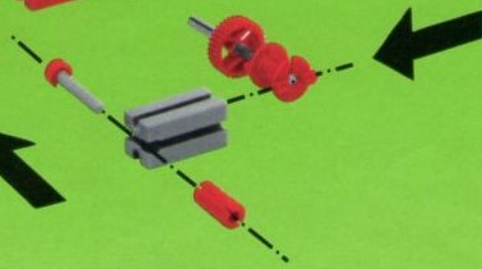
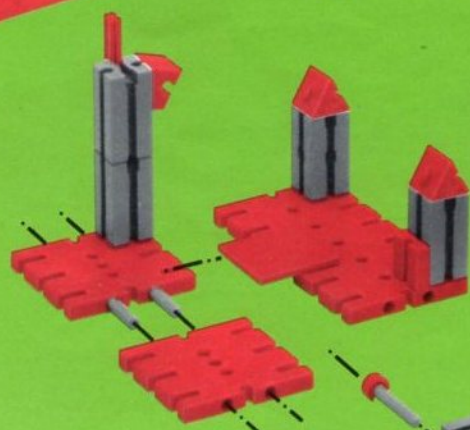
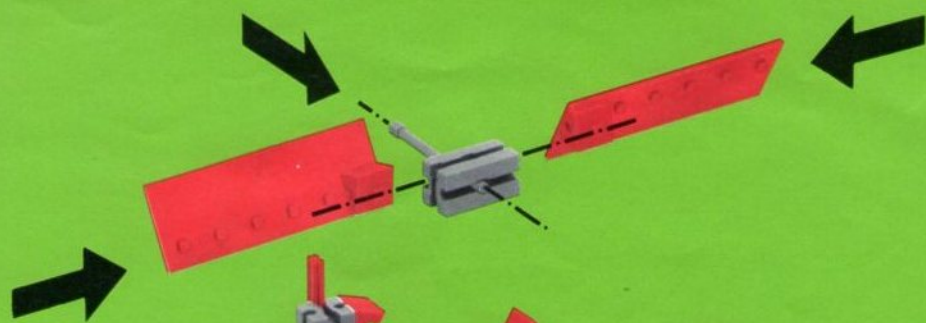

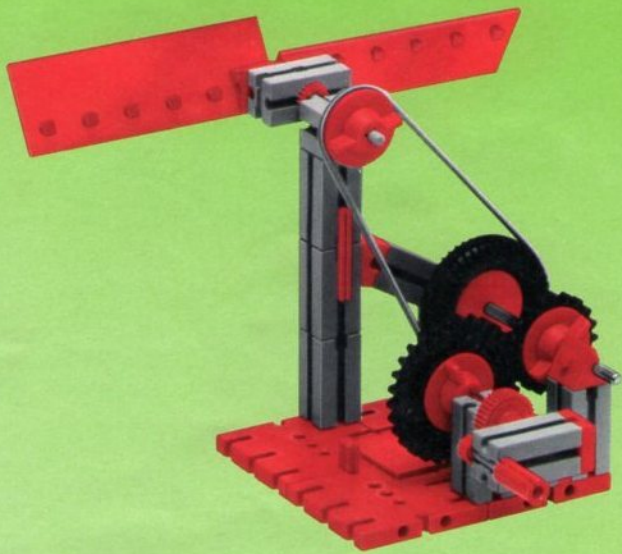

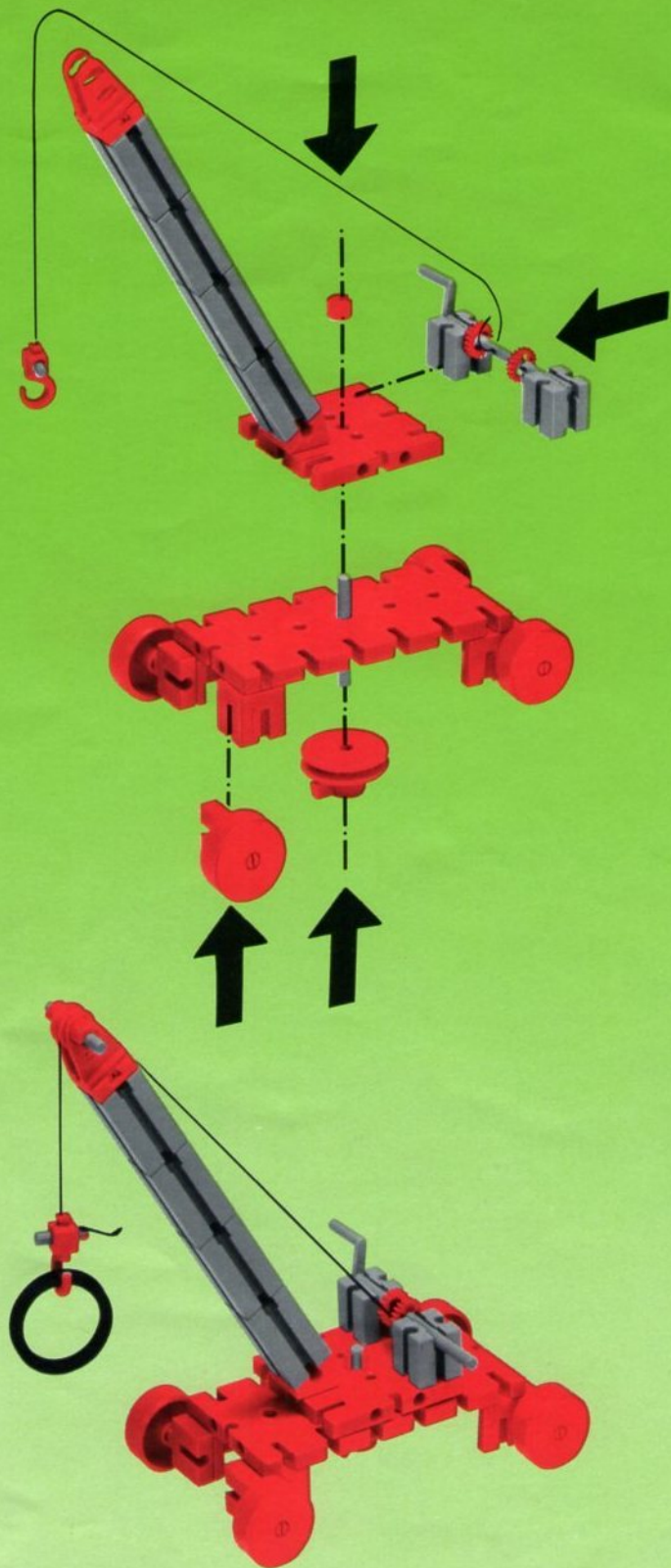



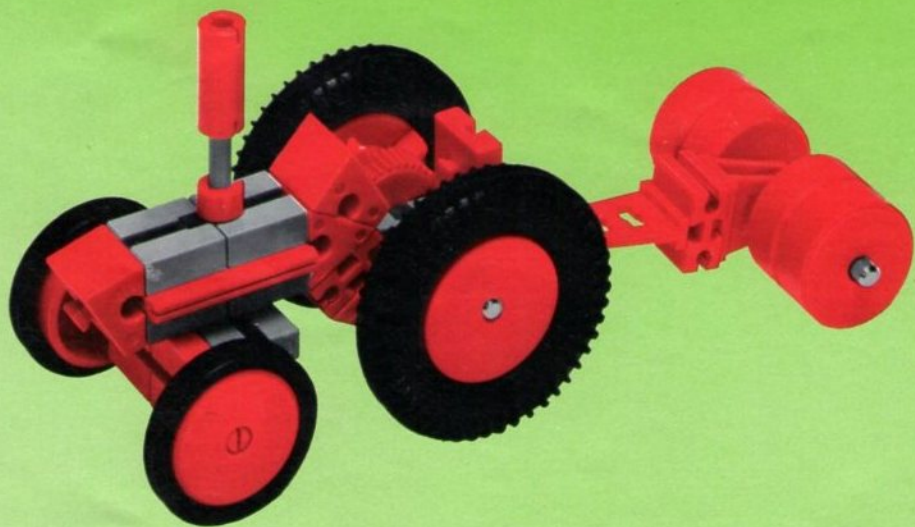
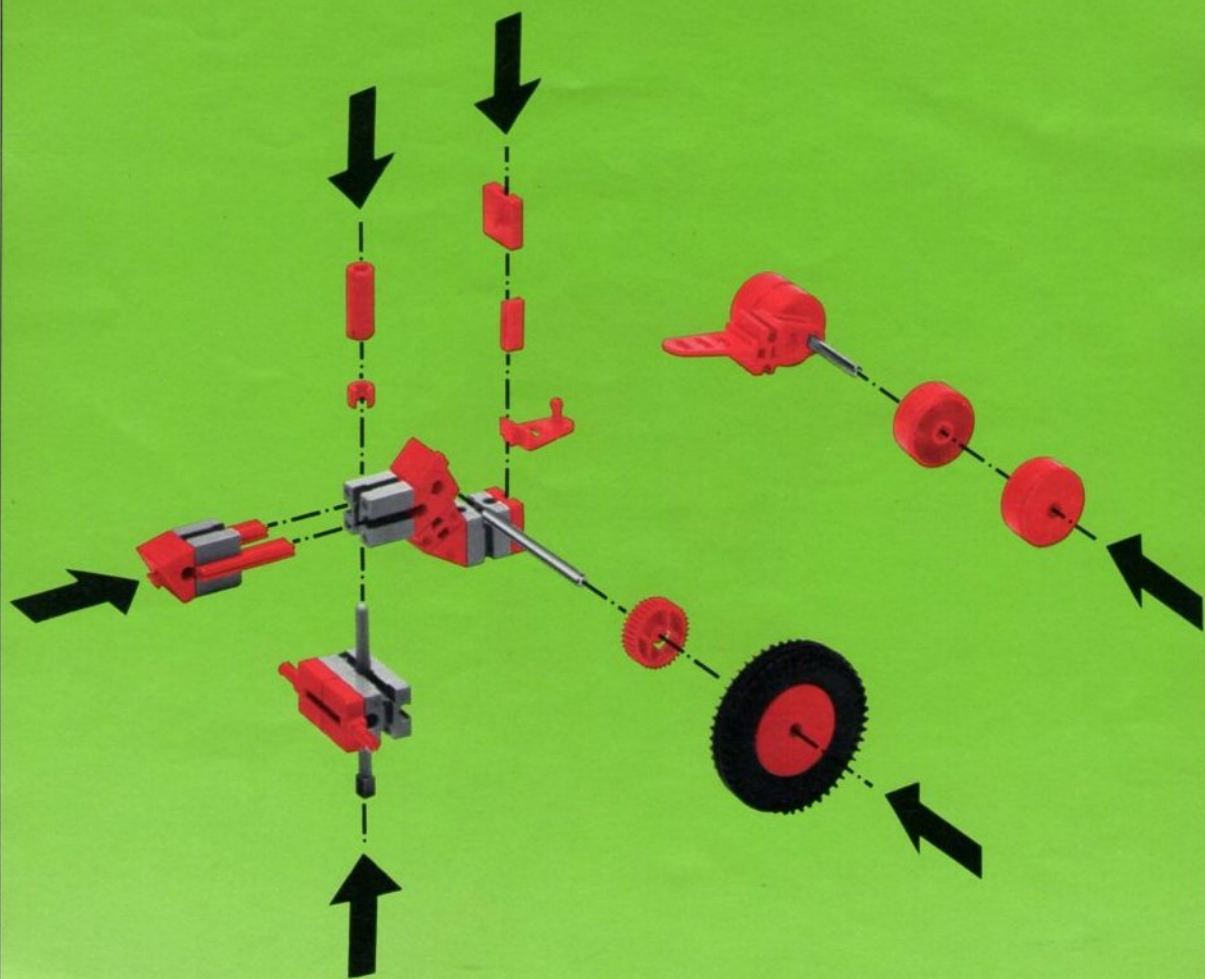

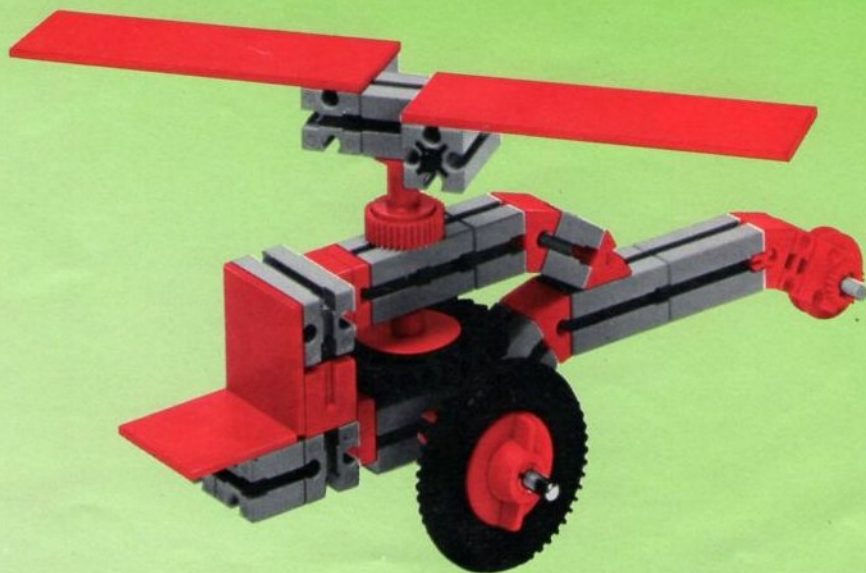
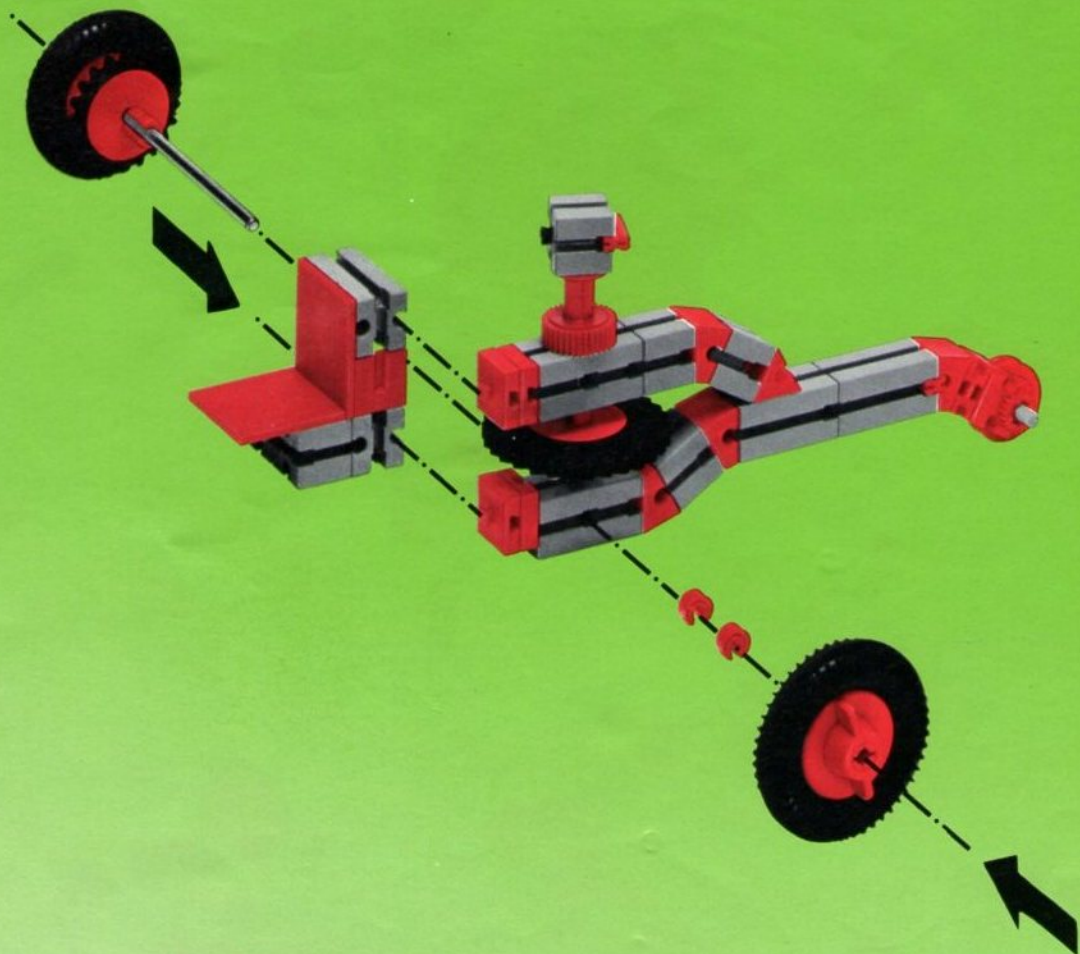

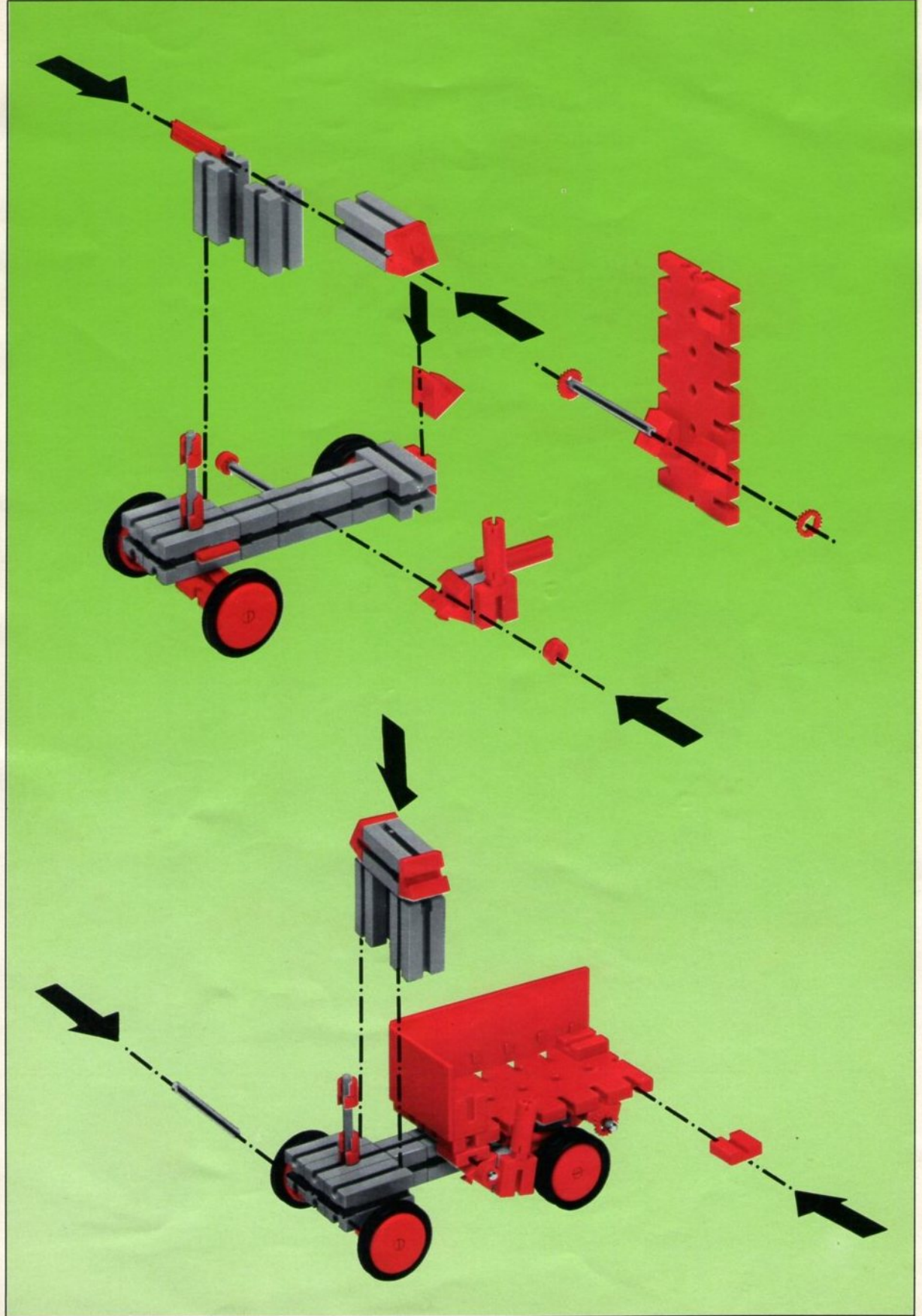





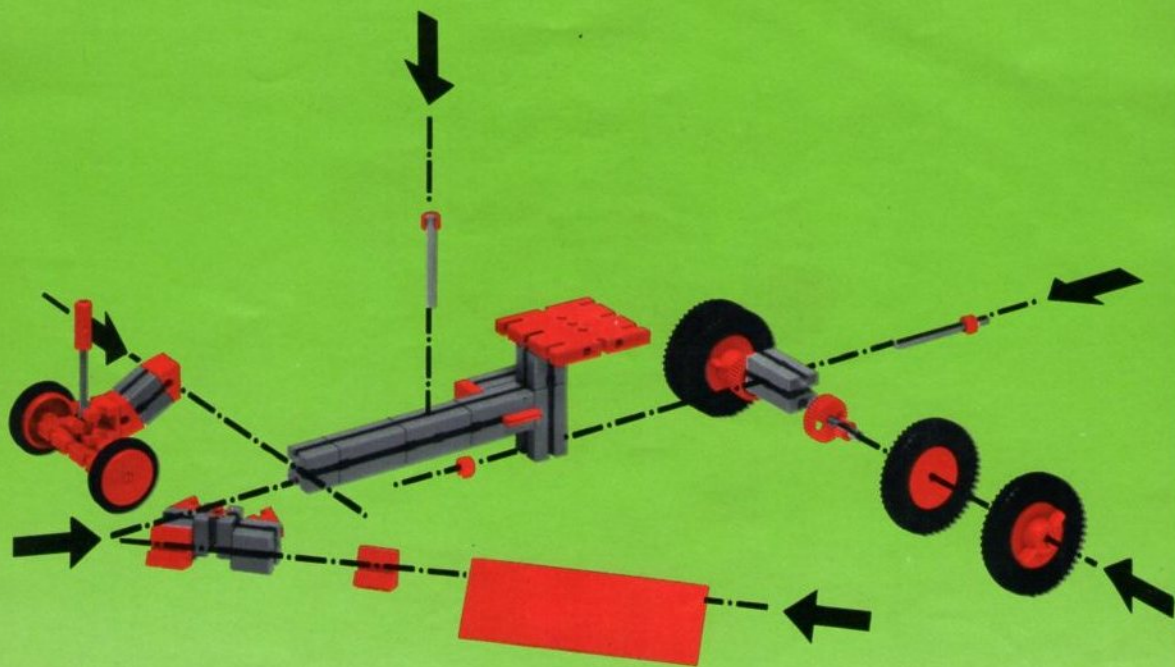

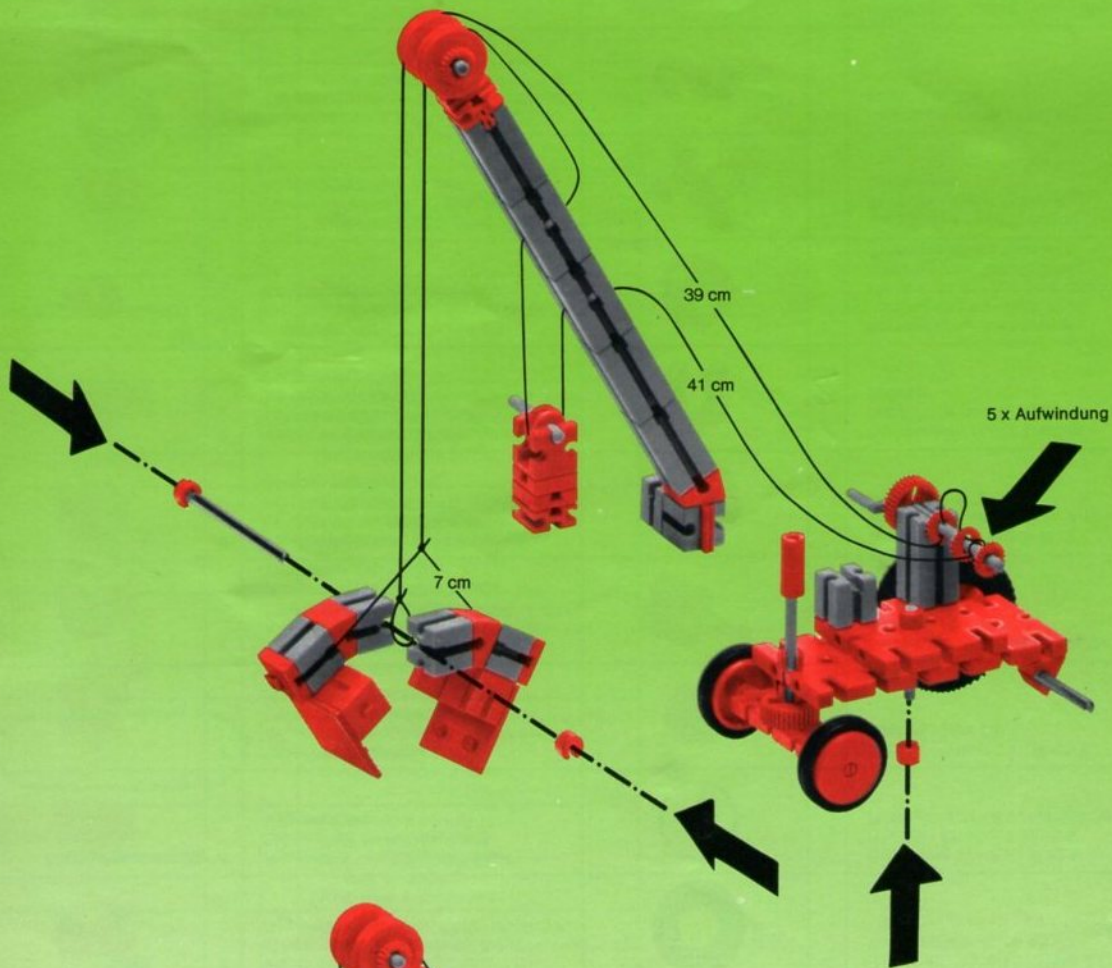



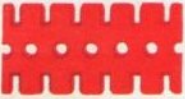



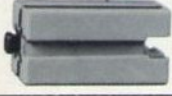

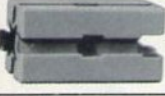



































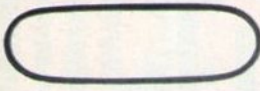

Stückliste · Part List · Nomenclature · Onderdelenlijst · Detalj översikt

	1	Grundplatte 90×45 · Baseplate 90×45 Plaque de base 90×45 · Basisplaat 90×45 · Bottenplatta 90×45		1	Nylonseil · Nylon line · Ficelle · Nylon draad · Nylonrep
	2	Grundplatte 45×45 · Baseplate 45×45 Plaque de base 45×45 · Basisplate 45×45 · Bottenplatta 45×45		5	Riegelscheibe · Blocking washer · Disque d'arrêt · Grendelschijf · Regelskiva
	7	Baustein 30 · Building block 30 · Élément de 30 · Bouwsteen 30 · Byggnadssten 30		6	Klemmbuchse 5 · Spring clip 5 · Baue de serrage 5 · Klämbussning 5
	2	Baustein 30 mit Bohrung · Building block 30 with bore · Élément de 30 percé · Bouwsteen 30 met boring · Byggnadssten 30 med borrhål		1	Klemmkupplung · Coupling · Manchon d'accouplement · Klemkoppeling · Klämkoppling
	6	Baustein 15 · Building block 15 · Élément de 15 · Bouwsteen 15 · Byggnadssten 15		4	Flachnabe · Flat hub · Moyeu plat · Platte naaf · Plattnav
	2	Baustein 15 mit rundem Zapfen · Building block 15 with round lug · Élément de 15 à tourillon · Bouwsteen 15 met ronde nokken · Byggnadssten med runda tappar		6	Reifen 30 · Tyre 30 · Pneu 30 · Wielband 30 · Däck 30
	2	Baustein 7,5 · Building block 7,5 · Élément de 7,5 · Bouwsteen 7,5 · Byggnadssten 7,5		4	Reifen 45 · Tyre 45 · Pneu 45 · Wielband 45 · Däck 45
	4	Baustein 5 · Building block 5 · Élément de 5 · Bouwsteen 5 · Byggnadssten 5		2	Gummiring 37×2,5 · Rubber ring 37×2,5 · Elastique 37×2,5 · Rubberring 37×2,5 · Gummiring 37×2,5
	2	Winkelstein gleichseitig · Angle block, equilateral · Élément angulaire équilateral · Hoeksteen · Vinkelsten, liksidig		6	Rad 23 · Wheel 23 · Roue 23 · Wiel 23 · Hjul 23
	4	Winkelstein gleichschenkelig · Angle block, isosceles · Élément angulaire isocèle · Hoeksteen met gelijke benen · Vinkelsten, rätvinklig		4	Radachse · Stub axle · Axe de roue · Wiel as · Hjul axel
	6	Verbindungsstück 15 · Connector 15 · Languette d'assemblage 15 · Verbindingsstuk 15 · Förbindningsstycke 15		2	Seilrolle Ø 12 · Pulley Ø 12 · Poulie Ø 12 · Snaarschijf Ø 12 · Lintrumma Ø 12
	2	Verbindungsstück 30 · Connector 30 · Languette d'assemblage 30 · Verbindingsstuk 30 · Förbindningsstycke 30		2	Rollenlager · Roller bearing · Support de poulie · Rollager · Rullager
	1	Kupplungsstück 1 · Coupling 1 · Élément d'attelage 1 · Koppelstuk 1 · Kopplingsselement 1		2	Klemmring für Seiltrommel · Locking ring for winch drum · Flasque de serrage pour tambour · Klemring voor kabeltrommel · Stoppning till lintrumma
	2	Kupplungsstück 2 · Coupling 2 · Élément d'attelage 2 · Koppelstuk 2 · Kopplingsselement 2		1	Seiltrommel · Winch drum · Tambour · Kabel trommel · Linktrumma
	2	Kupplungsstück 30 · Coupling 30 · Élément d'attelage 30 · Koppelstuk 30 · Kopplingsselement 30		1	Seilhaken · Hook · Crochet · Haak · Linkrok
	1	Lenkbalken · Link beam · Train avant · Stuurbalk · Styrbalk		1	Handkurbel · Crank · Manivelle · Handkruk · Handvev

Stückliste · Part List · Nomenclature · Onderdelenlijst · Detalj översikt

	1	Zahnrad Z 20 · Gearwheel Z 20 · Roue à 20 dents · Tandwiel Z 20 · Kuggjul Z 20
	1	Zahnrad Z 30 · Gearwheel Z 30 · Couronne à 30 dents m 1,5 · Tandwiel Z 30 · Kuggjul Z 30
	1	Seilrolle Ø 21 · Pulley Ø 21 · Poulie Ø 21 · Snaarschijf Ø 21 · Lintrumma Ø 21
	1	Kurbel 40 · Crankshaft 40 · Manivelle grise 40 · Kruk 40 · Vev 40
	2	Bauplatte 30×90 · Building plate 30×90 · Plaque à tenons 30×90 · Bouwplaat 30×90 · Byggnadsplatta 30×90
	2	Bauplatte 30×45 · Building plate 30×45 · Plaque à tenons 30×45 · Bouwplaat 30×45 · Byggnadsplatta 30×45
	2	Bauplatte 30×30 · Building plate 30×30 · Plaque à tenons 30×30 · Bouwplaat 30×30 · Byggnadsplatta 30×30
	1	Antriebsfeder 270 · Drive spring 270 · Ressort de transmission 270 · Aandrijfveer 270 · Drivande fjäder 270
	1	Achse mit 4-Kantansatz · Axle with square end · Axe gris à embout carré · As met 4-kantnok · Axel med 4-kantskarv
	1	Seilklemmstift 4×15 · Cord clamp 4×15 · Segment de blocage 4×15 · Draadklem 4×15 · Stift till kabelklämma 4×15
	4	Kunststoffachse 30 · Plastic axle 30 · Axe gris 30 · K-as 30 · Axel av syntetmaterial 30
	4	Baustein V-15-Eck · Building block V 15 corner · Pierre V 15 d'angle · Hoekbouwsteen V 15 · Hörnbyggsten V 15
	2	Achse 110 · Axle 4 1/4" approx. · Axe 110 · As 110 · Axel 110
	1	Achse 80 · Axle 3" approx. · Axe 80 · As 80 · Axel 80
	1	Achse 60 · Axle 2 1/2" approx. · Axe 60 · As 60 · Axel 60
	2	Achse 50 · Axle 2" approx. · Axe 50 · As 50 · Axel 50

